

LKTOP

KL340 M3行业探照灯

KL340 M3 Industry Searchlight

User Manual

用户手册

V1.0 2024.12

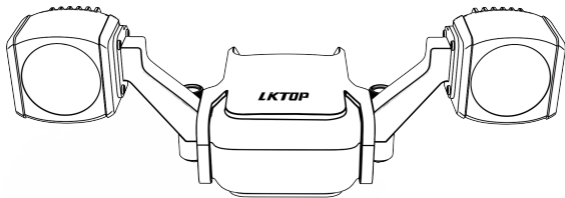

免责声明

感谢您购买LKTOP KL340 M3行业探照灯(以下简称“探照灯”)。在使用探照灯之前,请仔细阅读本声明,一旦使用本产品,即被视为对本声明全部内容的认可和接受。请严格遵守本说明使用该产品,并务必重视注意事项。因用户使用不当探照灯而造成的直接或者间接损失与伤害,立刻飞概不负责。

LKTOP为立刻飞所有的注册商标。本文出现的产品名称、品牌等,均为其所属公司的商标或注册商标。本产品及手册为立刻飞版权所有。未经许可,不得以任何形式复制翻印。使用本产品及手册不会追究专利责任。本文档及本产品所有的相关文档最终解释权归立刻飞所有。

关于不同语言版本的免责声明可能存在差异,中国以中文版为准,其他地区以英文版为准。

注意事项

- 使用本产品之前,请仔细阅读并遵循本文及本产品相关的所有安全与合规操作指引。
- 如遇硬件问题,请返厂联系售后服务,切勿自行拆卸维修,否则将失去保修、维修资格。
- 请勿手动来回快速旋转探照灯,否则由此带来的损坏自行承担!
- 灯筒散热片温度高,请勿触碰,防止烫伤,否则由此带来的伤害自行承担!

产品介绍

LKTOP KL340 M3行业探照灯，轻量化设计，重量 $\leq 105\text{g}$ ，功率 40w ，可发射出 13° 角锐利光束，有效探照距离达150米，亮度均匀，颜色一致性强，有效满足小型无人机夜晚巡查、方位指示、搜索救援等应用场景需求。

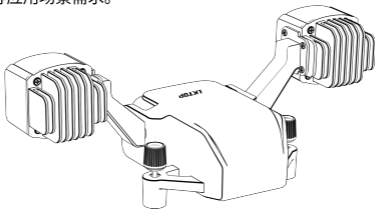

产品参数

型号	KL340
外形尺寸 /mm	长x宽x高:143x63x55mm
材质	ABS+PC、6063
安装方式	螺丝快拆
总重量 /g	$\leq 105\text{g}$
通讯链路	无人机链路
总功率 /W	$40\text{W}\pm 5\%$
光通量/lm	$3000\pm 5\%$ <small>(LED光源不带透镜实验室环境下测得)</small>
照明角度	13°
照明距离	50m 100m
照明面积	101m^2 407m^2
中心光照度	22.2lX 5.39lX
警灯模式	红蓝爆闪、蓝蓝爆闪、红红爆闪

安装说明

- 1、将探照灯对准飞机的安装孔对插完成后，手动拧紧两颗手拧螺丝。

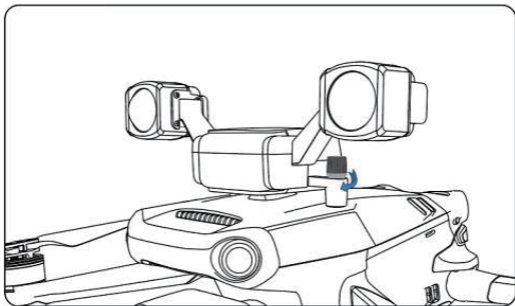
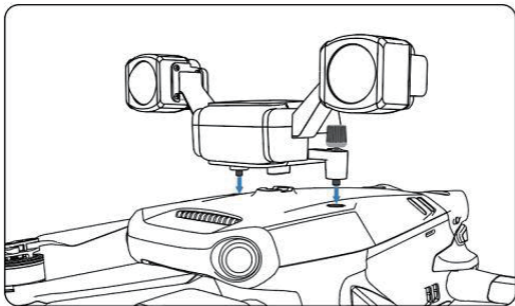

DJI Pilot 2 使用说明

- 1.将KL340安装在无人机上,正常打开无人机电源,启动无人机。
- 2.启动遥控器,打开DJI Pilot 2



进入主页面,显示KL340字样,说明负载连接成功,点击屏幕右下角进入飞行页面。

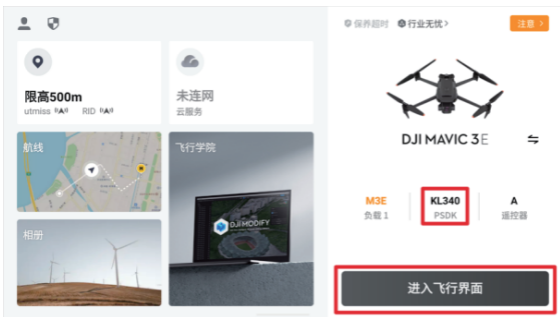

3.控件界面介绍

进入Pilot 2界面后,点击右侧最下按钮“psdk”,呈现出主功能界面。



右:1、信息栏 2、探照灯俯仰调节 3、探照灯锁定 4、探照灯常亮开关
左:1、探照灯爆闪开关 2、警灯控制 3、探照灯亮度控制

3.1 俯仰调节

点击上下方向可以手动控制探照灯俯仰角。

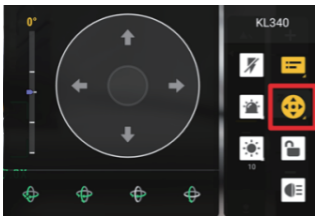

3.2 探照灯锁定

锁定探照灯位置,不再跟随相机。

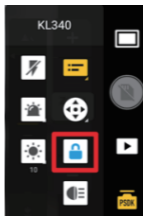

3.3 探照灯常亮开关

打开/关闭探照灯。

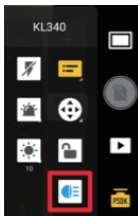

3.4 探照灯爆闪开关

打开/关闭探照灯爆闪。

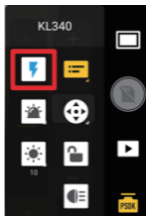

3.5 警灯控制

控制警灯的关闭/红蓝爆闪/
红爆闪/蓝爆闪模式切换。



3.6 探照灯亮度控制

调节探照灯的亮度

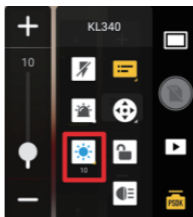

4、其他设置

点击右上角三点，找到“psdk”并点击。

其他功能：①开机提示灯 ②探照灯俯仰微调 ③保存微调 ④返航关灯

⑤关于：可查看PSDK版本和PSDK序列号

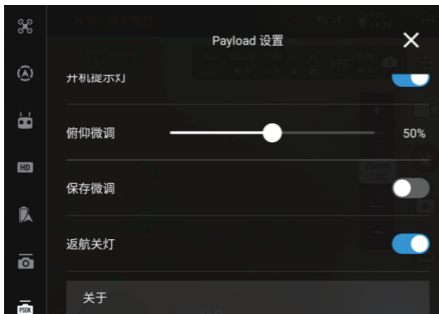

固件升级

1、大疆助手升级

探照灯安装在无人机上, 打开最新的DJI Assistant 2 (Enterprise Series)软件, 用type-c线连接无人机, 然后等待弹出设备。

选择固件即可升级。(不可进行降级或同版本升级)

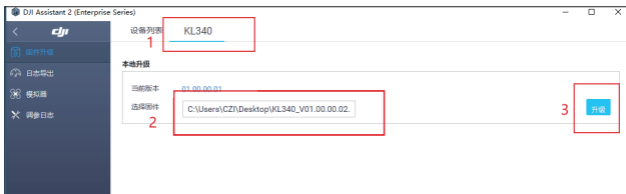

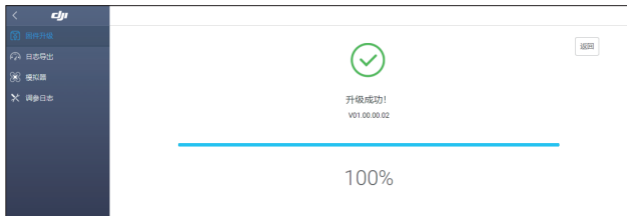
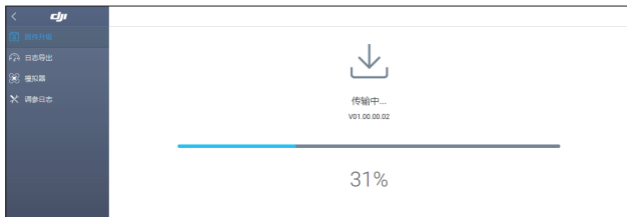

Disclaimers

Thank you for purchasing LKTOP KL340 M3 Industry Searchlight (hereinafter referred to as "Searchlight"). Before using the searchlight, please read this statement carefully. Once using this product, it is deemed to be an acknowledgement and acceptance of all the contents of this statement. Please strictly follow these instructions when using this product, and be sure to pay attention to the precautions. LKF is not responsible for any direct or indirect losses or injuries caused by improper use of searchlights by users.

LKTOP is a registered trademark of LKF Co., Ltd.(hereinafter referred to as the "LKF"). The product names and brands mentioned in this article are trademarks or registered trademarks of their respective companies. This product and manual are copyrighted by LKF. Without permission, no reproduction or copying is allowed in any form. The use of this product and manual will not be subject to patent liability, and the final interpretation rights of this document and all related documents of this product belong to LKF.

There may be differences in disclaimers for different language versions. The Chinese version shall prevail in China, and the English version shall prevail in other regions.

Precautions for product use

- Before using this product, please carefully read and follow all safety and compliance operating instructions related to this article and this product.
- If you encounter hardware problems, please return to the factory and contact after-sales service. Do not disassemble and repair on your own, otherwise you will lose your warranty and repair qualifications.
- Please do not manually rotate the searchlight back and forth quickly, otherwise any damage caused will be borne by yourself !
- The temperature of the heat sink of the lamp tube is high. Please do not touch it to prevent burns, otherwise the damage caused by it will be borne by yourself !

Product introduction

LKTOP KL340 M3 Industry Searchlight, lightweight design, weight $\leq 105\text{g}$, power 40w , can emit a sharp beam of light at a 13° angle, effective illumination distance of up to 150 meters, uniform brightness, high color consistency, effectively meeting the needs of small unmanned aerial vehicles for night patrols, direction indication, search and rescue applications.

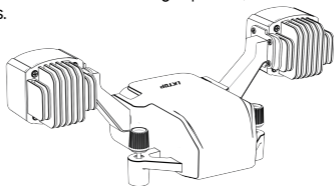

Product parameters

Model	KL340
Dimensions/mm	Length x Width x Height: 143 x 63 x 55mm
Texture of material	ABS+PC、6063
Installation method	Screw quick disassembly
Total weight/g	$\leq 105\text{g}$
Communication link	UAV link
Total power/W	$40\text{W} \pm 5\%$
Luminous flux/lm	$3000 \pm 5\%$ <small>(LED light source measured in laboratory environment without lens)</small>
Lighting angle	13°
Lighting distance	50m 100m
Lighting area	101m^2 407m^2
Central illuminance	22.2lx 5.39lx
Police light mode	Red blue explosion flash, blue blue explosion flash, red red explosion flash

Installation instruction

1. After aligning the searchlight with the installation hole of the aircraft and inserting it, manually tighten the two hand screws.

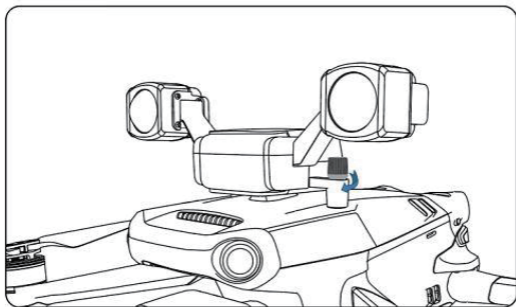
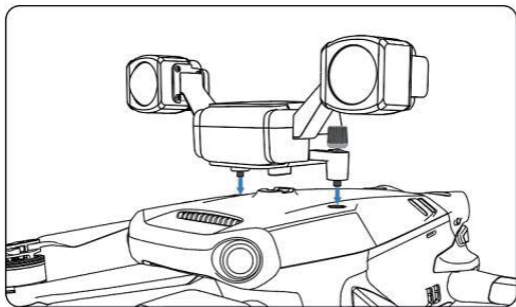

DJI Pilot 2 User Manual

1. Install KL340 on the drone, turn on the drone power normally, and start the drone.
2. Activate the remote control and turn on DJI Pilot 2.



Enter the main page and display the word KL340, indicating successful load connection. Click on the bottom right corner of the screen to enter the flight page.

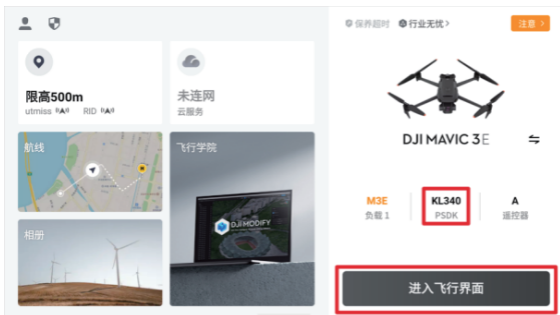

3. Introduction to Control Interface

After entering the Pilot 2 interface, click the bottom right button "psdk" to display the main function interface.



- Right: 1. Information bar 2. Searchlight pitch adjustment 3. Searchlight lock
4. Searchlight constant on switch
- Left: 1. Searchlight flashing switch 2. Alarm light control
3. Searchlight brightness control

3.1 Pitch adjustment

Click the up and down direction to manually control the tilt angle of the searchlight.

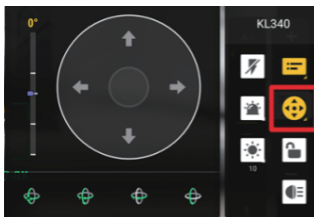

3.2 Searchlight locking

Lock the position of the searchlight and no longer follow the camera.

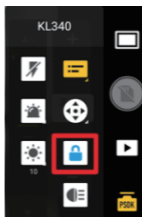

3.3 Searchlight constant on switch

Turn on/off the searchlight.

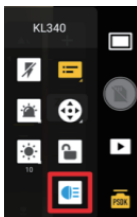

3.4 Searchlight explosion switch

Turn on/off the flashing of the searchlight.

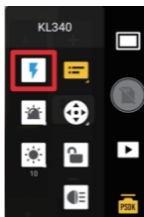

3.5 Police light control

Control the turn off of alarm lights/red and blue flashing/Red/Blue Flashing Mode Switching.



3.6 Searchlight brightness control

Adjust the brightness of the searchlight

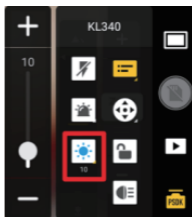

4. Other settings

Click on the three dots in the upper right corner, find "psdk" and click on it.

- Other functions:
- ① Power on indicator light
 - ② Tilt adjustment of searchlight
 - ③ Save adjustment
 - ④ Turn off lights when returning
 - ⑤ Regarding: Viewing PSDK version and PSDK serial number

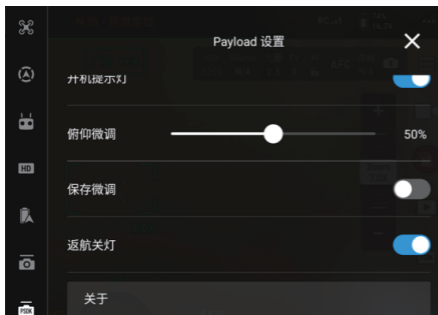

Firmware update

1. DJI Assistant Upgrade

Install the searchlight on the drone, open the latest DJI Assistant 2 (Enterprise Series) software, and connect it with a type-c cable
 Pick up the drone and wait for the device to pop up.
 Select firmware to upgrade. (Cannot downgrade or upgrade to the same version)

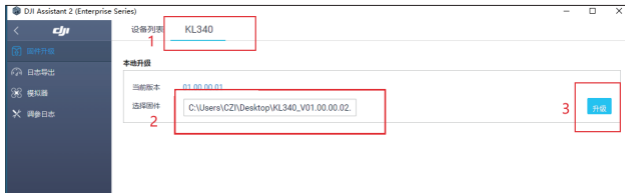

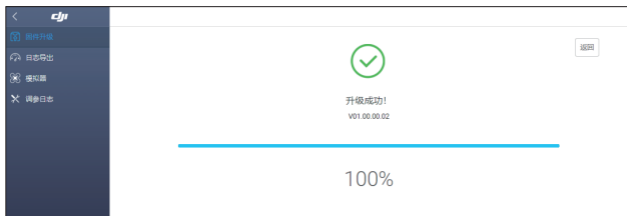
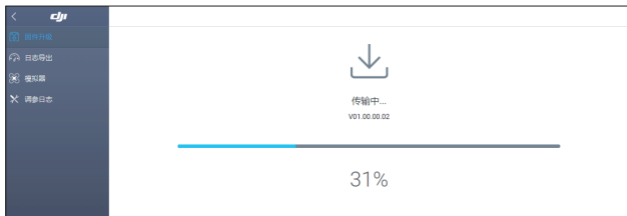

合格证 /Certificate

产品型号/Model	KL340
检验员/QC	

装箱清单 /Packing List

名称/Name	数量/Quantity
KL340主机 / KL340 Host	1
说明书/ Instructions	1
合格证/ Certificate	1

WE ARE HERE FOR YOU

在线技术支持



Scan Wechat
Obtain Technical Support
微信扫一扫 获取技术支持



Scan Wechat
Follow LKTOP Official Account
微信扫一扫 关注LKTOP公众号



Scan the code to watch it
扫码观看

This manual is subject to updates without prior notice.

本手册如有更新，恕不另行通知。

You can check the latest version on the LKTOP official website

您可以在LKTOP官方网站查询最新版本

<https://www.lktop.cn>

If you have any questions or suggestions about the manual,
please contact us via the following email:

如果您对说明书有任何疑问或建议，请通过以下电子邮箱联系我们：

service@lktop.cn

LKTOP is a trademark of LKF.

LKTOP 是立刻飞的商标。

Copyright © 2024立刻飞版权所有